

PLEASE READ THE INSTRUCTIONS BEFORE OPERATING THIS PRODUCT

WAND OPERATION-DRAW

Use the wand to draw the slats to either end of the blind.

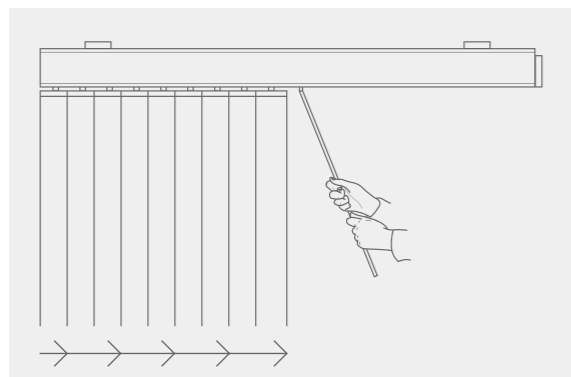

If any of the slats are out of alignment, twist the wand control until the slats are in the closed position, then continue to twist the wand until all the slats are fully aligned. You may feel some resistance and hear a clicking noise whilst doing so.

MAINTENANCE

The product is low maintenance, however we recommend that regular visual checks are completed to ensure that no components have been damaged, which could result in operating difficulties and/or cause a safety risk.

To ensure the slats slide smoothly across the headrail apply some silicone base lubricant spray to inside of the headrail.

If any maintenance is required we recommend that the work is carried out immediately by a reputable blind company.

WAND OPERATION-TILT

Twist the wand to tilt the slats in either direction to the open/closed position.

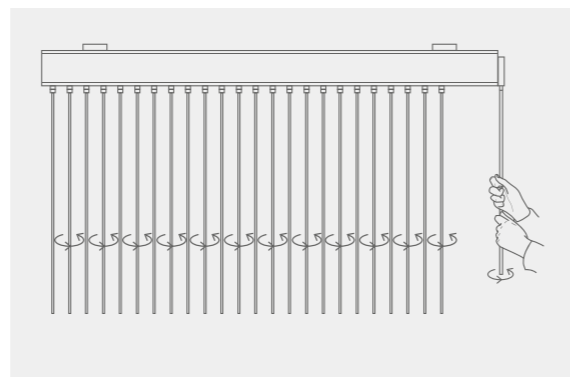

make it safeTM

BBSA[®]
BRITISH BLIND & SHUTTER ASSOCIATION

WARNING

Young children can be strangled by loops in pull cords, chains, tapes and inner cords that operate the product.

To avoid strangulation and entanglement, keep cords out of the reach of young children. Cords may become wrapped around a child's neck. Move beds, cots and furniture away from window covering cords.

Do not tie cords together. Make sure cords do not twist and create a loop.

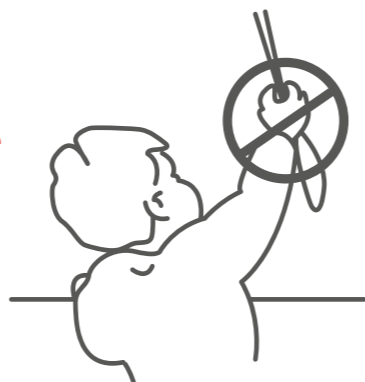

Vertical Blinds

YOU SHOULD HAVE

VERTICAL ITEM LIST

Brackets



Safety device

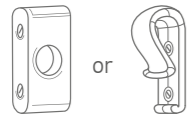

TOOLS REQUIRED

Screw driver Drill

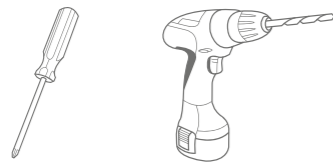

Tape measure Pencil

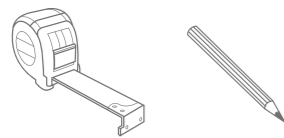

STEP 1

The installation of this product should be conducted by someone competent in DIY.

OUTSIDE RECESS

If the blind is to be fitted outside the window ensure that measurement C is the same. Follow instructions for FACE FIXING. To calculate $C=(A-B)/2$.

INSIDE RECESS

TOP FIX to the lintel or FACE FIX brackets to the window frame.

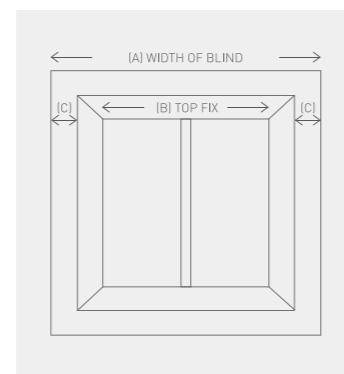

STEP 2

TOP FIXING

Measure and mark the distance (D), allowing for obstructions like handles that protrude into the recess area. Position brackets approx 5cm from the ends of where the headrail is to be positioned. If more than 2 brackets are supplied, fit the additional brackets at equal spacing across the length of the blind. Please ensure fixings are suitable for the wall/surface to which you are mounting the brackets.

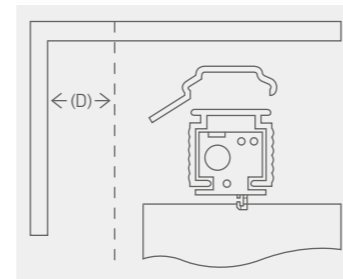

FACE FIXING

Position brackets approx 5cm from the ends of where the headrail is to be positioned. If more than 2 brackets are supplied, fit the additional brackets at equal spacing across the length of the blind. Please ensure fixings are suitable for the wall/surface to which you are mounting the brackets.

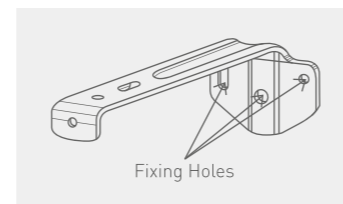

STEP 3

TOP FIXING

Tilt and hook headrail into bracket at point (E). Rotate the headrail into position until it clicks. To release the headrail push the bracket at point (F).

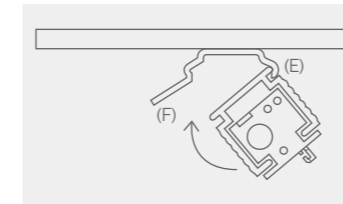

FACE FIXING

Hook the back of the headrail into the bracket and rotate the headrail into position. Secure headrail by tightening the short screw in the front of the bracket.

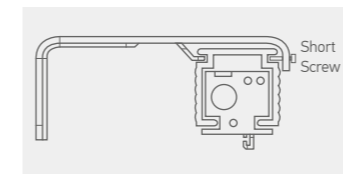

STEP 4

SAFETY DEVICE

The safety device must be installed at the maximum distance possible from the control mechanism to prevent looped chain becoming slack.

Place the safety device on the wall and mark the positioning of the 2 screw holes.

Drill holes using a suitable drill bit.

Place device into position ensuring the chain is fully taut.

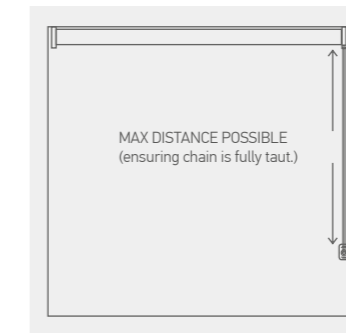

STEP 5

RETAINING DEVICE

Screw the retaining device using suitable fixings ensuring the device is fully closed.

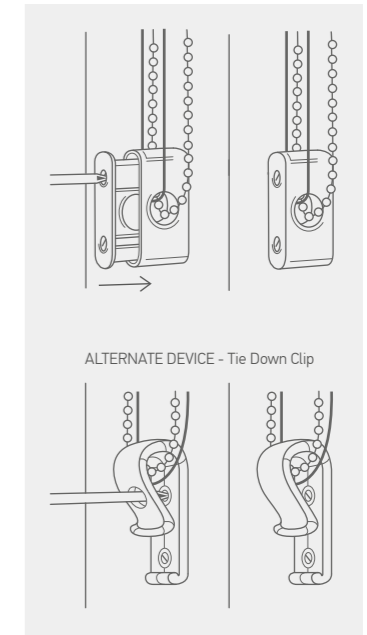

STEP 6

ATTACHING VERTICAL VANE

With the headrail fitted, hook each fabric/PVC slat into the headrail travellers ensuring the traveller pegs are in the open position.

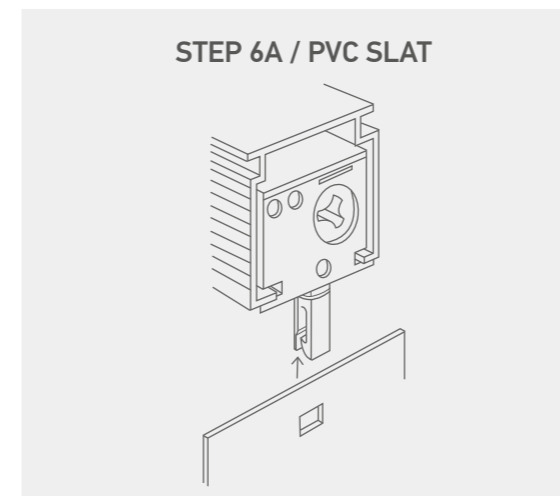

Children can strangle if a safety device is not installed. Always use a safety device to keep cords and chains out of reach of children.