

Vertical Blinds - 89mm (3.5") Slats / Louvres

0161 451 0290

Tips:

Use a metal tape measure to ensure accurate measurements

Bracket Types for Vertical Blinds (these are chosen during the ordering process)

1) Top Fix: fitted 75mm away from the window frame

ALLOWANCE FOR MEASURING: 75MM

gives a clearance of approx 25mm between louvre and fitting surface (if you have window handles, add the depth of the handle to 75mm to achieve the correct fitting distance from the frame).

2) Small face fix: fitted 75mm away from the window frame

ALLOWANCE FOR MEASURING: 75MM

gives a clearance of approx 25mm between louvre and fitting surface

3 Large face fix: fitted 110mm away from the window frame

ALLOWANCE FOR MEASURING: 110MM

gives a clearance of approx 60mm between louvre and fitting surface which will clear most handles.

Angled Bay Window - Go to Page 2

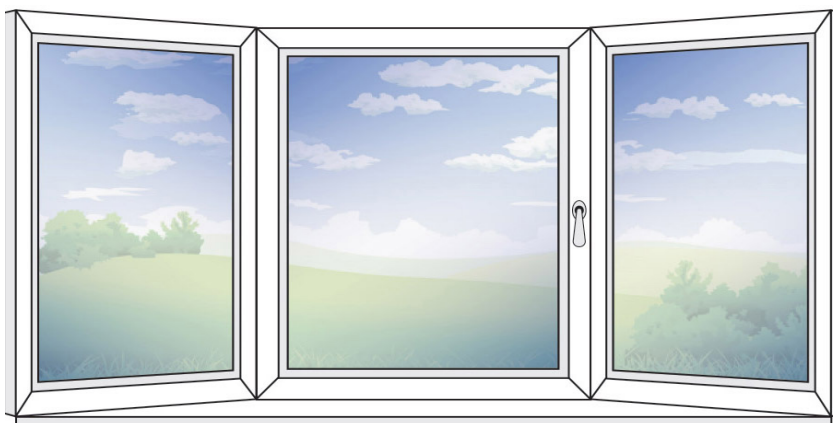

Boxed / Square Bay Window - Go to Page 3

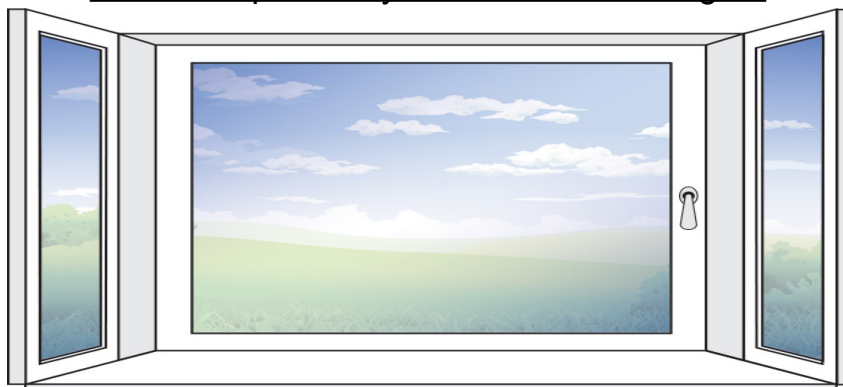

Angled Bay Window Measuring Instructions

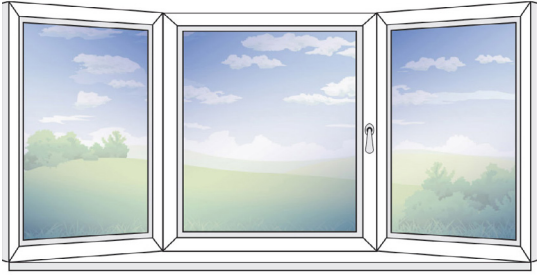

Items Needed:

- 2 pieces of paper A4 or A5
- Pencil
- Metal tape measure
- Ruler

1

If you have window handles measure how far out they protrude, then add this to the allowance for the bracket in the table at the top of the page. Note the size down, this will be referred to as X.

$X = \text{window handle size} + \text{bracket size}$

Place the two pieces of paper next to each other and mark a line at measurement X.

Shade in to mark frame side of paper

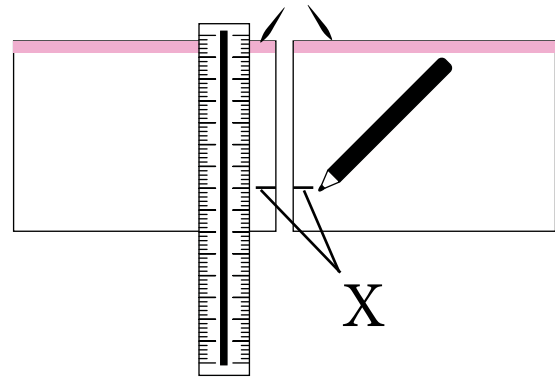

2

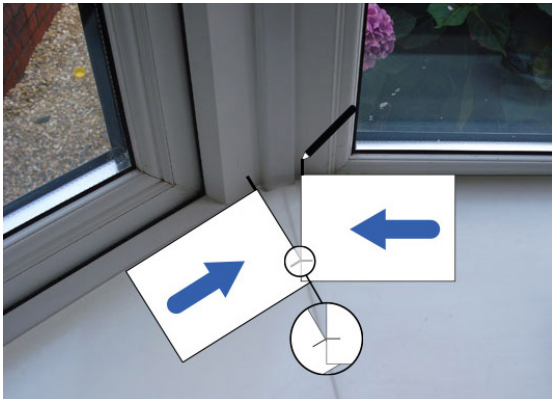

1) Place the pieces of paper on the window sill touching the frame and slide together until the two lines meet.

2) Then using a pencil make a mark on the window sill at the point where the corner of the paper meets the frame.

3) Repeat on other angles around the bay.

3

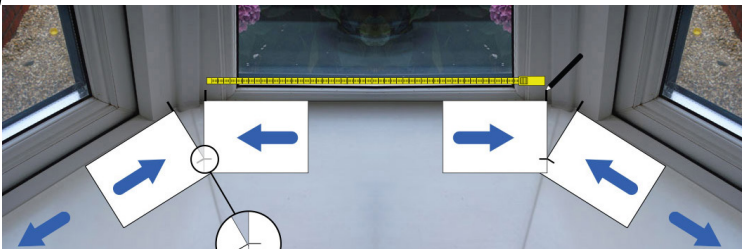

Measure from one mark to the next as shown on the illustration.

This will give you the widths the blinds will need to be.

Order all blinds as **RECESS SIZE**.

4 **Drop**

For the drop measure from where the bracket is to be fitted to the window sill.

Order all blinds as **RECESS SIZE**.

Box / Square Bay Window Measuring Instructions



Items Needed:

- Pencil
- Metal tape measure

1

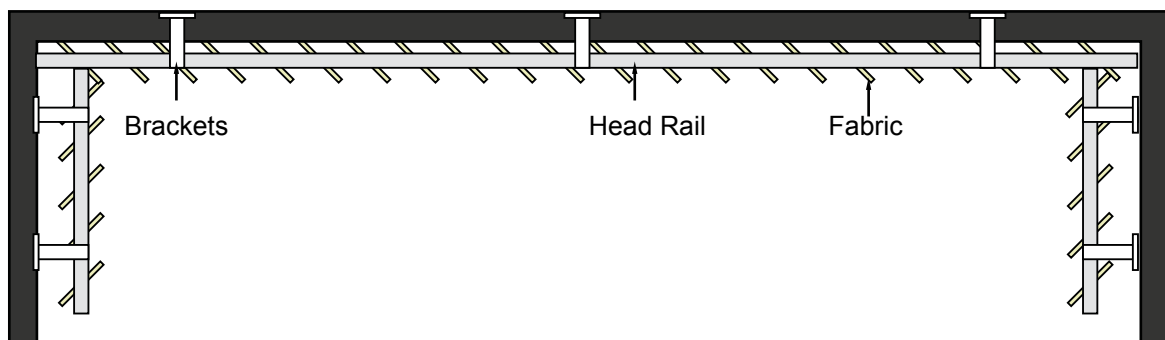

2

Important Advice:

Decide the best bracket type/size. Top fix brackets are chosen when you have a flat and stable top surface to fit into. Face fix are normally used if the top surface is not strong enough to support the brackets or if there isn't one i.e. conservatories.

WIDTH:

- 1) Measure the full width of all 3 windows into the corners, note the sizes down.
- 2) Depending on the bracket size chosen deduct 75mm or 110mm from the full width of each side blind. This allows for the space taken by the front blind.
- 3) Order all 3 blinds a **RECESS SIZE**.

DROP:

Firstly make sure you have at least 30mm clear on the surface you are mounting the blinds to. On a bay window you need to order all 3 blind at the same drop even if one window is longer than the others. Measure from the point where the bracket is to be fitted, to the window sill and use the smallest of the three as your drop.

Questions? Need any help? We are here 9-5 Monday to Friday and would be more than happy to help over the phone with any measuring advice you may need.