

Measuring Instructions: Wooden Venetian Blinds For Angled Bay Windows

Angled Bay Window



Tips

Use a metal tape measure to ensure accurate measurements

Bracket Dimensions

25mm/35mm Slat Sizes
Depth: 53mm | Height 65mm

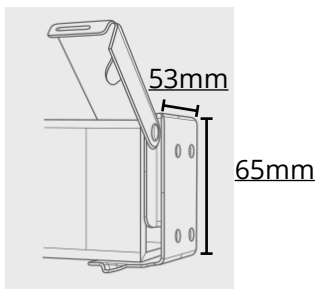

50mm Slat Sizes
Depth: 56mm | Height 71mm

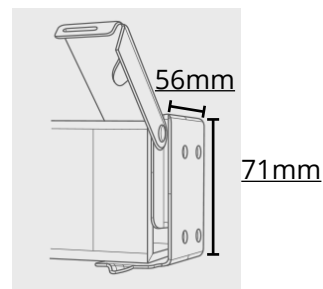

Headrail & Valance Dimensions

25mm/35mm Slat Sizes
Depth including valance: 57mm | Height 42mm

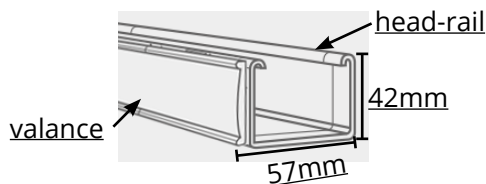

50mm Slat Sizes
Depth including valance: 74mm | Height 42mm

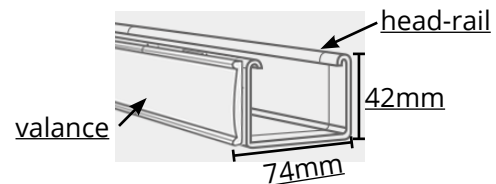

Step 1: Choose the slat size .

When measuring for angled bay windows you need to allow for the head-rail and valance depth and window handles which affect the size of the blind when fitted.

There are 3 different slats sizes which will affect the sizes of the brackets and head-rail.

Once you have chosen the slat size you can use the illustration above to determine the allowance which will be referred to as **X** for the next step.

Headrail Allowance:

25mm / 35mm slat size: X = 57mm

50mm slat size: X = 74mm

Step 2

Find the handles allowance. If you have window handles, measure how far out they protrude. e.g. 5.5cm (55mm) in the image opposite. This will be referred to as **Y** for the next step.

example **Y = 55mm**

Step 2

Calculate total allowance.

Add (**Y**) to the allowance for the head-rail and valance depth (**X**) that you noted down from the previous page to get **Z**.

Total allowance will be calculated using the following:

$$X + Y = Z$$



Step 3

Take an A4 sheet of paper and cut in half. Place the two pieces of paper next to each other and mark a line at measurement **Z**.

e.g.

50mm slat size, window handles 55mm

$$74\text{mm (x)} + 55\text{mm (Y)} = 129\text{mm (Z)}$$

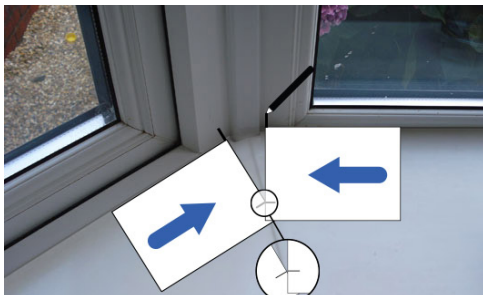
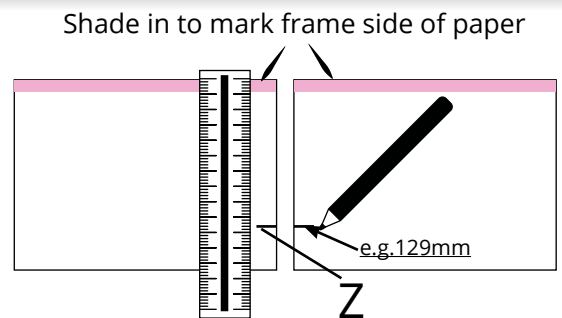

- 1) Place the pieces of paper on the window sill touching the frame and slide together until the two lines meet.
- 2) Then using a pencil make a mark on the window sill at the point where the corner of the fabric meets the frame.
- 3) Repeat on the other angles around the bay.

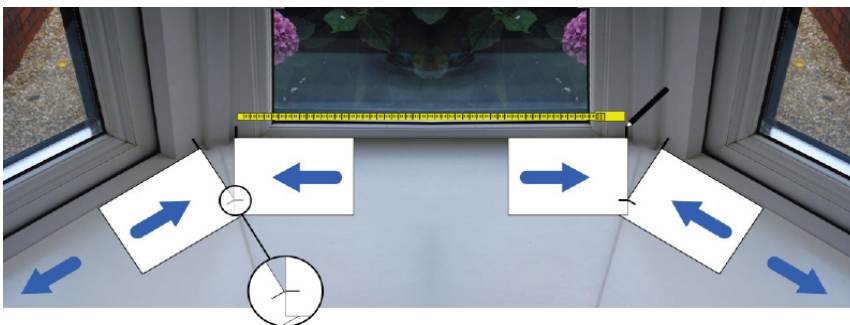

Measure the distance between the two pencil marks on each window around the bay as shown on the illustration. This will give you the widths the blinds will need to be.

Order all blinds as **EXACT SIZE**

Drop

Measure from where the top of the bracket is to be fitted to the window sill. Check the drop all around the bay as it will often differ.

Order all blinds as **EXACT SIZE.**